

SPECYFIKACJA TECHNICZNA

KOLORYSTYKA

BLAT, WIENIEC GÓRNY, WIENIEC DOLNY

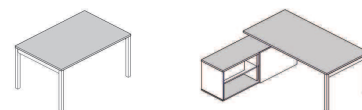

FRONT

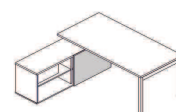

KORPUS - I GRUPA CENOWA

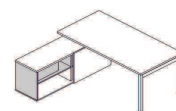

KORPUS - II GRUPA CENOWA

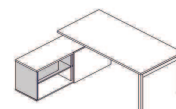
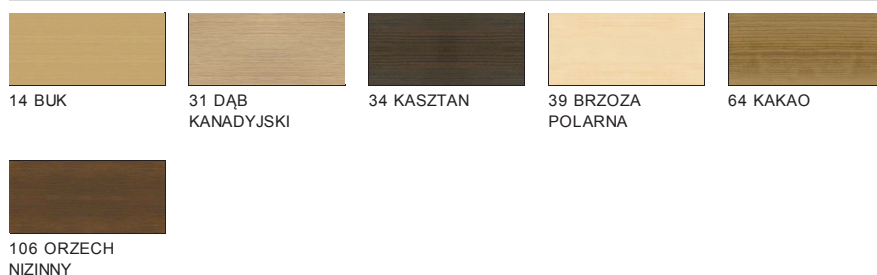

STELAŻ, OSŁONA PŁYTOWA - OGI_N

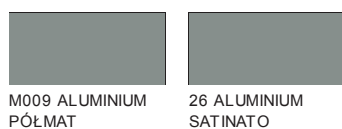
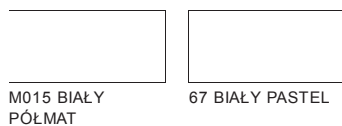

SPECYFIKACJA TECHNICZNA

KOLORYSTYKA

NOGI PŁYTOWE, OSŁONA PŁYTOWA - OGI_V

26 ALUMINIUM
SATINATO

67 BIAŁY PASTEL



154 ANTRACYT

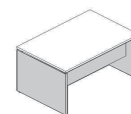

STELAŻ - OGI_A, OGI_Q, OGI_U, OGI_Y

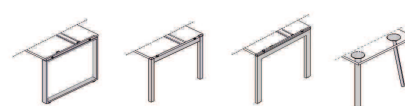
M009 ALUMINIUM
PÓŁMATM015 BIAŁY
PÓŁMATM154 ANTRACYT
PÓŁMAT

PRZYSTAWKI DO BIUREK - BLAT - PLU01, PLY01

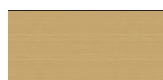

14 BUK

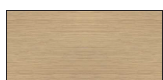
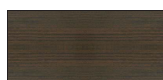
26 ALUMINIUM
SATINATO31 DĄB
KANADYJSKI

34 KASZTAN

39 BRZOZA
POLARNA

64 KAKAO

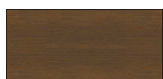

67 BIAŁY PASTEL

106 ORZECH
NIZINNY

154 ANTRACYT

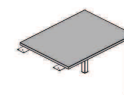
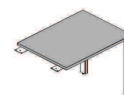

PRZYSTAWKI DO BIUREK - STELAŻ - PLU01, PLY01

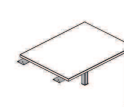
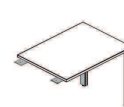
M009 ALUMINIUM
PÓŁMATM015 BIAŁY
PÓŁMATM154 ANTRACYT
PÓŁMAT

PRZELOTY KABLOWE - CZARNY

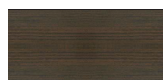

34 KASZTAN

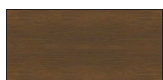

64 KAKAO

106 ORZECH
NIZINNY

154 ANTRACYT

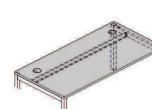

PRZELOTY KABLOWE - BIURKA - BLAT, NOGA, ŁĄCZYNA



67 BIAŁY PASTEL

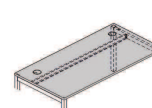

PRZELOTY KABLOWE - ALUMINIOWY

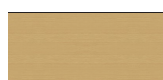

14 BUK

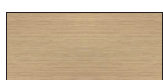
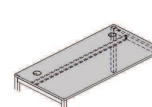
26 ALUMINIUM
SATINATO31 DĄB
KANADYJSKI39 BRZOZA
POLARNA

SPECYFIKACJA TECHNICZNA

BLATY BIUREK OGI

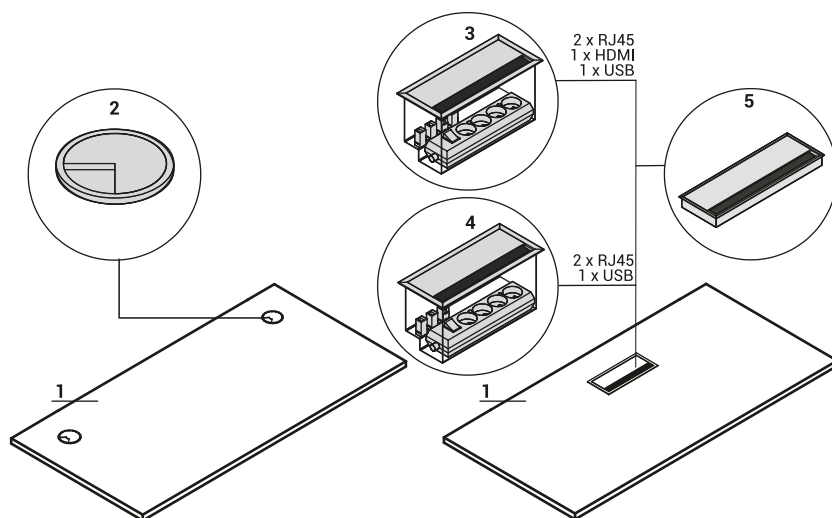

1. **Blat** - płyta melaminowana 28mm, obrzeża PVC
2. **OPCJA Z DOPŁATĄ** - 2 x przepust kablowy PVC - \varnothing 80mm
3. **OPCJA Z DOPŁATĄ** - Mediabox M04H - 2xRJ45 (class E, cat. 6) + 1 x USB + 1 x HDMI + 4 x 230V, kolor: M009 - aluminium półmat
4. **OPCJA Z DOPŁATĄ** - Mediabox M04 - 2xRJ45 (class E, cat. 6) + 1 x USB + 4 x 230V, kolor: M009 - aluminium półmat
5. **OPCJA Z DOPŁATĄ** - Top access M05 - kolor: M009 - aluminium półmat

BLAT - KONFIGURACJE

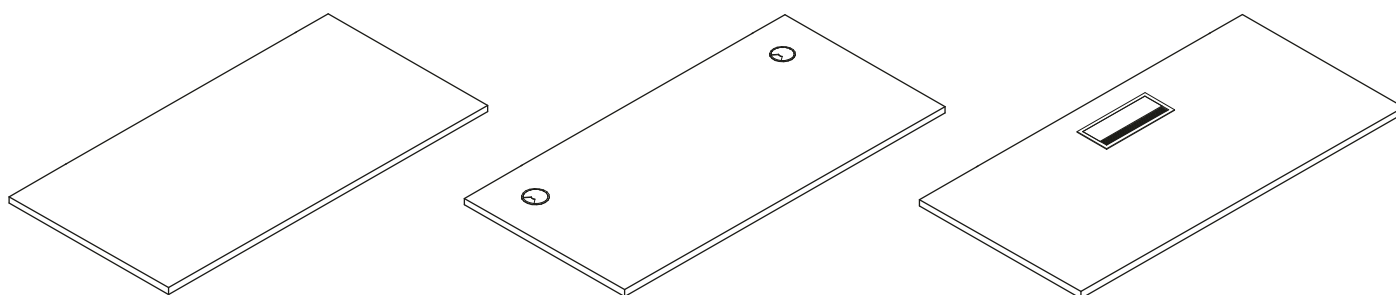

STELAŻ

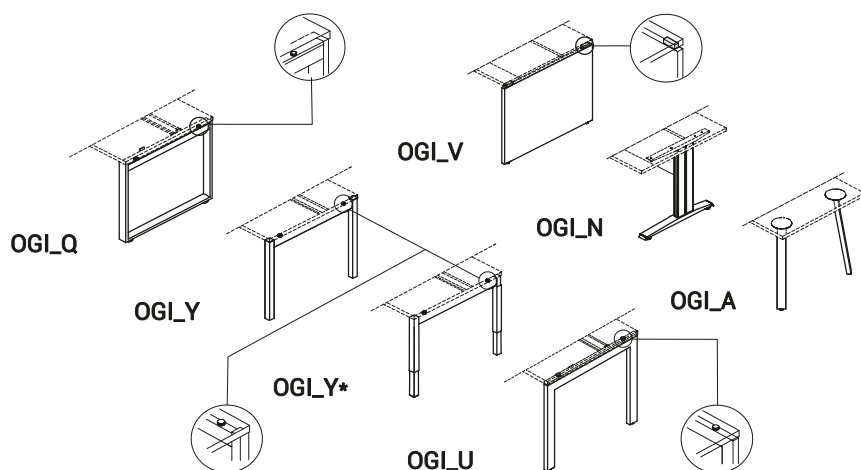

- OGI Q** - metal malowany proszkowo, profil 60x20mm, między blatem a stelażem dystans 15mm
- OGI Y** - metal malowany proszkowo, profil 40x40mm, między blatem a stelażem dystans 10mm
- *OGI Y z regulacją wysokości** - metal malowany proszkowo, 2 nakładane profile 30x30 i 40x40 mm, regulacja w zakresie 640 - 860 mm, skokowo co 20 mm
- OGI U** - metal malowany proszkowo, profil 60x30mm, między blatem a stelażem dystans 10mm
- OGI V** - nogi - płyta 28mm, łączyna - płyta 18mm, między blatem a nogą dystans aluminiowy 60x20mm
- OGI N** - metal malowany proszkowo, kolumna 642x149x36mm, stopa 647x60mm, pionowe prowadzenie okablowania, łączyna - płyta melaminowana 18mm
- OGI A** - metal malowany proszkowo, profil 60x30mm

SPECYFIKACJA TECHNICZNA

PRZYSTAWKI DO BIUREK

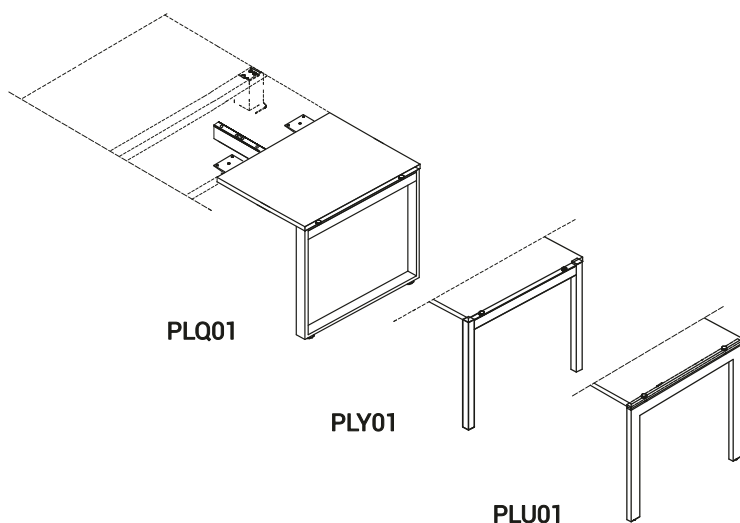

PLQ01 - przystawka z nogą OGI Q

PLU01 - przystawka z nogą OGI U

PLY01 - przystawka z nogą OGI Y

BIURKO Z SZAFKĄ MANAGERSKĄ

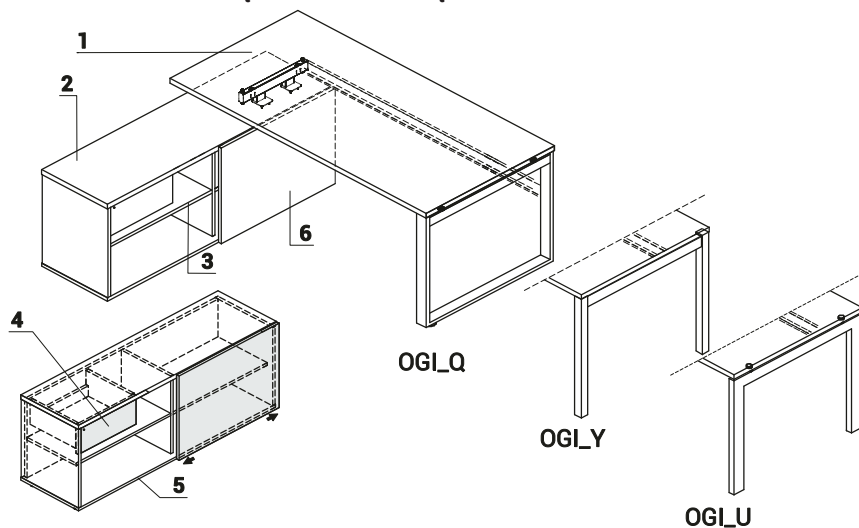

1. **Blat** - płyta melaminowana 28mm, obrzeża PVC

2. **Wieniec górny** - płyta melaminowana 28mm, obrzeża PVC

3. **Półka** - płyta melaminowana 18mm, obrzeża PVC

4. **Szuflada** - płyta melaminowana 18mm, obrzeża PVC, zamek patentowy - możliwość zmiany usytuowania

5. **Wieniec dolny** - płyta melaminowana 18mm, obrzeża PVC

6. **Front** - płyta melaminowana 18mm, obrzeża PVC

PRZYKŁADOWE KONFIGURACJE

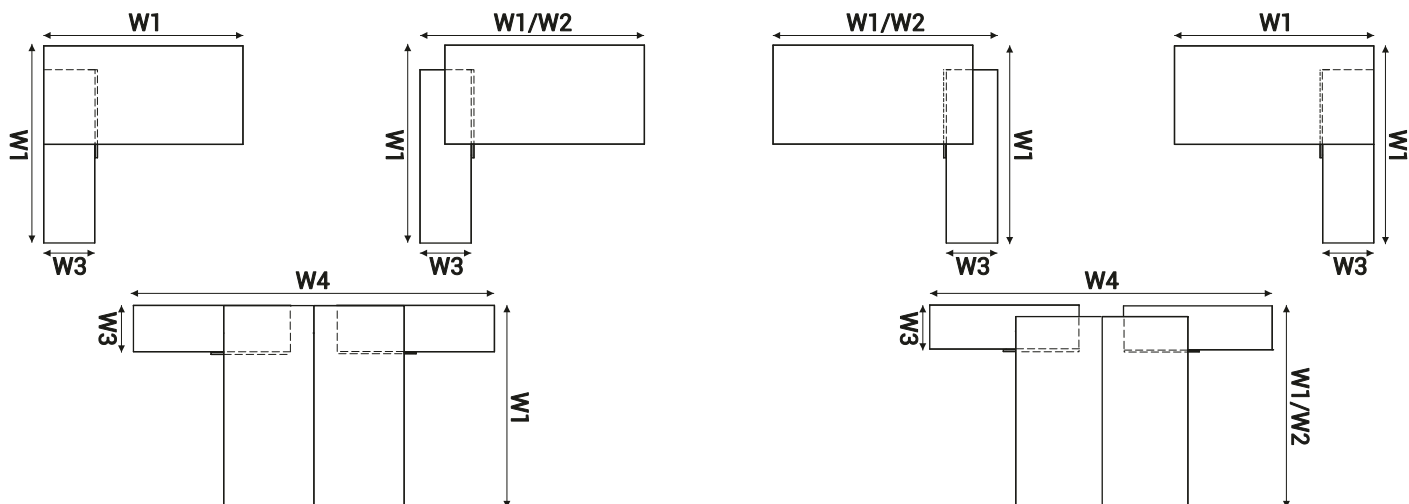

W1 - 1600 | W2 - 1702 | W3 - 432 | W4 - 3218

SPECYFIKACJA TECHNICZNA

AKCESORIA

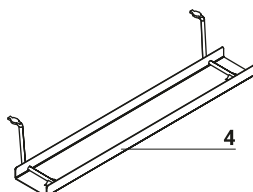
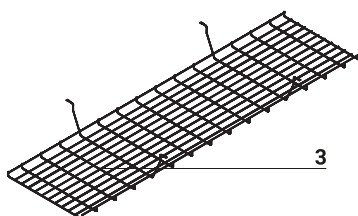
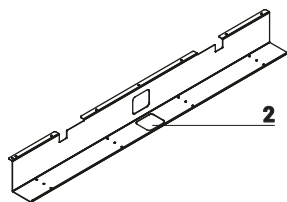
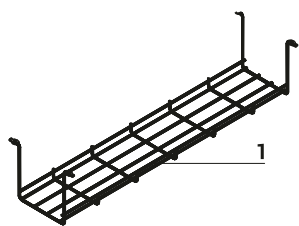

1. Szyna S69 - metal malowany proszkowo, kolor: 09 - aluminium
2. Szyna do pojedynczego biurka (SG12, SG16) - metal malowany proszkowo, kolor: M009 - aluminium półmat
3. Szyna do biurek typu bench (SG220, SG260) - drut stalowy Ø4mm, malowany proszkowo, kolor: 09 - aluminium
4. Szyna E64 - metal malowany proszkowo, kolor: M009 - aluminium półmat

WYMIARY BLATÓW KSZTAŁTOWYCH

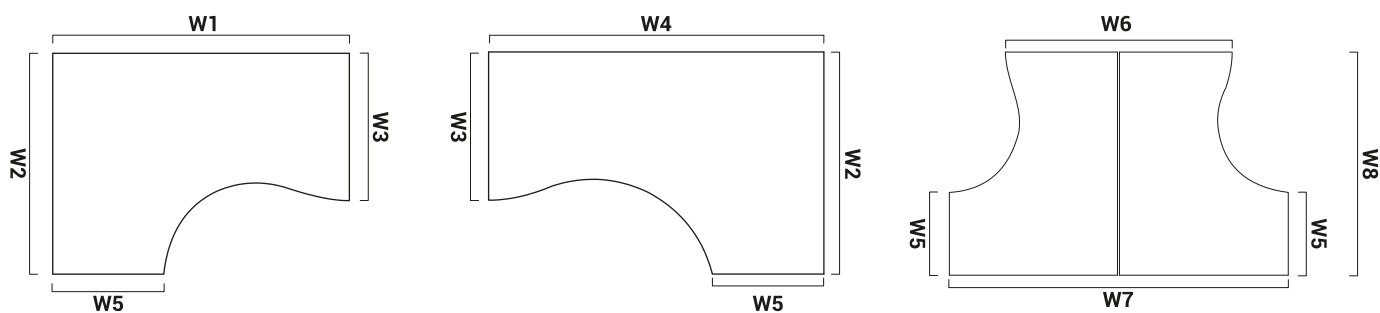

W1 - 1600mm | W2 - 1200mm | W3 - 800mm | W4 - 1800mm | W5 - 600mm | W6 - 1610mm | W7 - 2410mm | W8 - 1600mm

WIDOK I RZUT OBIEKTU	WYMIARY [mm]			SYMBOL	CENA NETTO PLN				UWAGI
	SZEROKOŚĆ	GLĘBOKOŚĆ	WYSOKOŚĆ			kg	m3	szt	

BIURKA PROSTE

	1200	600	740	BAG026	425,-	25.0	0.035	5	
	1400	600	740	BAG036	435,-	24.0	0.039	5	
	1600	600	740	BAG046	445,-	26.0	0.043	5	
	1200	700	740	BAG027	435,-	24.0	0.039	5	
	1400	700	740	BAG037	445,-	27.0	0.044	5	
	1600	700	740	BAG047	455,-	29.0	0.049	5	
	1200	800	740	BAG028	445,-	26.0	0.043	5	
	1400	800	740	BAG038	455,-	29.0	0.049	5	
	1600	800	740	BAG048	465,-	32.0	0.055	5	

DODATKOWA DOPLATA DO CECHY

CECHA	SYMBOL												UWAGI
	BAG026	BAG036	BAG046	BAG027	BAG037	BAG047	BAG028	BAG038	BAG048	kg	m3	szt	
PRZEPUSTY KABLOWE	40,-	40,-	40,-	40,-	40,-	40,-	40,-	40,-	40,-	0.1	0.0001	1	
MEDIABOX M04H	490,-	490,-	490,-	490,-	490,-	490,-	490,-	490,-	490,-	0.9	0.0070	1	
MEDIABOX M04	450,-	450,-	450,-	450,-	450,-	450,-	450,-	450,-	450,-	0.9	0.0070	1	
TOP ACCESS M05	150,-	150,-	150,-	150,-	150,-	150,-	150,-	150,-	150,-	0.0	0.0000	0	

LEGENDA:

- WAGA NETTO

- OBJĘTOŚĆ

- ILOŚĆ PACZEK

WIDOK I RZUT OBIEKTU	WYMIARY [mm]			SYMBOL	CENA NETTO PLN				UWAGI
	SZEROKOŚĆ	GŁĘBOKOŚĆ	WYSOKOŚĆ			kg	m3	szt	

BIURKA KSZTAŁTOWE

	1600	1200	740	BAG10	578,-	37.0	0.078	5	
	1600	1200	740	BAG11	578,-	37.0	0.078	5	
	2343	2029	740	BAG12	1 575,-	93.6	0.198	15	możliwość zastosowania paneli ZOT78, ZOT79, ZOS78, ZOS79

BIURKA TYPU BENCH

	1600	1210	740	BAG0214	775,-	48.0	0.082	8	możliwość montażu tylko szyny SG22
	1600	1410	740	BAG0216	795,-	54.0	0.094	8	możliwość montażu tylko szyny SG22
	1600	1610	740	BAG0218	820,-	60.0	0.105	8	możliwość montażu tylko szyny SG22

ELEMENTY DO TWORZENIA UKŁADÓW BIUREK

	1600	1210	740	BAG0414	510,-	42.0	0.076	5	środkowa noga prosta wykonana z profilu 40x40
	1600	1410	740	BAG0416	525,-	48.0	0.088	5	środkowa noga prosta wykonana z profilu 40x40
	1600	1610	740	BAG0418	555,-	54.0	0.099	5	środkowa noga prosta wykonana z profilu 40x40

DODATKOWA DOPLATA DO CECHY



CECHA	SYMBOL												UWAGI
	BAG10	BAG11		BAG0214	BAG0216	BAG0218	BAG0414	BAG0416	BAG0418	kg	m3	szt	
PRZEPUSTY KABLOWE	40,-	40,-		80,-	80,-	80,-	80,-	80,-	80,-	0.1	0.0001	1	
MEDIABOX M04H	490,-	490,-		980,-	980,-	980,-	980,-	980,-	980,-	0.9	0.0070	1	
MEDIABOX M04	450,-	450,-		900,-	900,-	900,-	900,-	900,-	900,-	0.9	0.0070	1	
TOP ACCESS M05	150,-	150,-		300,-	300,-	300,-	300,-	300,-	300,-	0.0	0.0000	0	

LEGENDA:









- WAGA NETTO

- OBJĘTOŚĆ



- ILOŚĆ PACZEK

WIDOK I RZUT OBIEKTU	WYMIARY [mm]			SYMBOL	CENA NETTO PLN				UWAGI
	SZEROKOŚĆ	GLĘBOKOŚĆ	WYSOKOŚĆ			kg	m3	szt	

BIURKA PROSTE

	1200	600	740	BOQ12	595,-	32.0	0.093	4	
	1400	600	740	BOQ14	615,-	35.0	0.099	4	
	1600	600	740	BOQ16	635,-	38.1	0.104	4	
	1200	800	740	BOQ02	615,-	41.0	0.117	3	
	1400	800	740	BOQ03	635,-	41.5	0.124	3	
	1600	800	740	BOQ04	655,-	42.1	0.131	3	
	1800	800	740	BOQ05	725,-	45.2	0.138	3	
	2000	800	740	BOQ06	765,-	51.5	0.145	3	

DODATKOWA DOPLATA DO CECHY

CECHA	SYMBOL												UWAGI
	BOQ12	BOQ14	BOQ16	BOQ02	BOQ03	BOQ04	BOQ05	BOQ06		kg	m3	szt	
PRZEPUSTY KABLOWE	40,-	40,-	40,-	40,-	40,-	40,-	40,-	40,-		0.1	0.0001	1	
MEDIABOX M04H	490,-	490,-	490,-	490,-	490,-	490,-	490,-	490,-		0.9	0.0070	1	
MEDIABOX M04	450,-	450,-	450,-	450,-	450,-	450,-	450,-	450,-		0.9	0.0070	1	
TOP ACCESS M05	150,-	150,-	150,-	150,-	150,-	150,-	150,-	150,-		0.0	0.0000	0	

LEGENDA:

 - WAGA NETTO - OBJĘTOŚĆ - ILOŚĆ PACZEK

WIDOK I RZUT OBIEKTU	WYMIARY [mm]			SYMBOL	CENA NETTO PLN				UWAGI
	SZEROKOŚĆ	GŁĘBOKOŚĆ	WYSOKOŚĆ			kg	m3	szt	

ELEMENTY DO TWORZENIA UKŁADÓW BIUREK

	1200	800	740	BOX42	430,-	31.6	0.079	3	mocowanie wyłącznie do krawędzi 800mm, profil 40x40mm
	1400	800	740	BOX43	445,-	32.1	0.086	3	mocowanie wyłącznie do krawędzi 800mm, profil 40x40mm
	1600	800	740	BOX44	460,-	32.7	0.093	3	mocowanie wyłącznie do krawędzi 800mm, profil 40x40mm
	1800	800	740	BOX45	490,-	35.8	0.100	3	mocowanie wyłącznie do krawędzi 800mm, profil 40x40mm

BIURKA Z SZAFKĄ MANAGERSKĄ

	1600 1702	1600	740	BOQL20	1 735,-	94.4	0.249	8	uniwersalne (lewe / prawe)
	1800 1902	1600	740	BOQL21	1 750,-	97.5	0.256	8	uniwersalne (lewe / prawe)
	1600 1702	3210	740	BOQL40	3 445,-	185.8	0.498	15	
	1800 1902	3210	740	BOQL41	3 475,-	192.0	0.511	15	

DODATKOWA DOPLATA DO CECHY

CECHA	SYMBOL											UWAGI
	BOX42	BOX43	BOX44	BOX45	BOQL20	BOQL21	BOQL40	BOQL41	kg	m3	szt	
PRZEPUSTY KABLOWE	40,-	40,-	40,-	40,-	40,-	40,-	80,-	80,-	0.1	0.0001	1	
MEDIABOX M04H	490,-	490,-	490,-	490,-	490,-	490,-	980,-	980,-	0.9	0.0070	1	
MEDIABOX M04	450,-	450,-	450,-	450,-	450,-	450,-	900,-	900,-	0.9	0.0070	1	
TOP ACCESS M05	150,-	150,-	150,-	150,-	150,-	150,-	300,-	300,-	0.0	0.0000	0	
II GRUPA CENOWA					75,-	75,-	150,-	150,-	0.0	0.0000	0	

LEGENDA:

- WAGA NETTO

- OBJĘTOŚĆ

- ILOŚĆ PACZEK

WIDOK I RZUT OBIEKTU	WYMIARY [mm]			SYMBOL	CENA NETTO PLN				UWAGI
	SZEROKOŚĆ	GLĘBOKOŚĆ	WYSOKOŚĆ			kg	m3	szt	

BIURKA TYPU BENCH

	1200	1610	740	BOQ32	1 005,-	61.6	0.235	5	
	1400	1610	740	BOQ33	1 040,-	62.6	0.249	5	
	1600	1610	740	BOQ34	1 080,-	63.8	0.263	5	
	1800	1610	740	BOQ35	1 120,-	70.0	0.276	5	

ELEMENTY DO TWORZENIA UKŁADÓW BIUREK

	1200	1610	740	BOX62	695,-	60.1	0.159	5	
	1400	1610	740	BOX64	720,-	61.1	0.173	5	
	1600	1610	740	BOX66	760,-	62.3	0.187	5	
	1800	1610	740	BOX68	880,-	68.5	0.200	5	

DODATKOWA DOPLATA DO CECHY

CECHA	SYMBOL											UWAGI
	BOQ32	BOQ33	BOQ34	BOQ35	BOX62	BOX64	BOX66	BOX68	kg	m3	szt	
PRZEPUSTY KABLOWE	80,-	80,-	80,-	80,-	80,-	80,-	80,-	80,-	0.1	0.0001	1	
MEDIABOX M04H	980,-	980,-	980,-	980,-	980,-	980,-	980,-	980,-	0.9	0.0070	1	
MEDIABOX M04	900,-	900,-	900,-	900,-	900,-	900,-	900,-	900,-	0.9	0.0070	1	
TOP ACCESS M05	300,-	300,-	300,-	300,-	300,-	300,-	300,-	300,-	0.0	0.0000	0	

LEGENDA:

- WAGA NETTO

- OBJĘTOŚĆ

- ILOŚĆ PACZEK

WIDOK I RZUT OBIEKTU	WYMIARY [mm]			SYMBOL	CENA NETTO PLN				UWAGI
	SZEROKOŚĆ	GŁĘBOKOŚĆ	WYSOKOŚĆ			kg	m3	szt	

PRZYSTWKA DO BIUREK

	600	800	740	PLQ01	470,-	19.5	0.051	5	
	600	1000	740	PLQ02	505,-	20.7	0.056	5	
	600	1200	740	PLQ03	535,-	23.2	0.061	5	

LEGENDA:

- WAGA NETTO

- OBJĘTOŚĆ

- ILOŚĆ PACZEK

WIDOK I RZUT OBIEKTU	WYMIARY [mm]			SYMBOL	CENA NETTO PLN				UWAGI
	SZEROKOŚĆ	GŁĘBOKOŚĆ	WYSOKOŚĆ			kg	m3	szt	

BIURKA PROSTE

	1200	800	740	BNG02	500,-	32.6	0.100	3	
	1400	800	740	BNG03	520,-	37.0	0.108	3	
	1600	800	740	BNG04	545,-	41.9	0.122	3	
	1800	800	740	BNG05	580,-	45.3	0.124	3	

BIURKA KSZTAŁTOWE

	1600	1200	740	BNG10	695,-	45.9	0.145	3	należy zastosować odpowiednią nogę podpierającą
	1600	1200	740	BNG11	695,-	45.9	0.145	3	należy zastosować odpowiednią nogę podpierającą
	1800	1200	740	BNG17	780,-	52.9	0.149	3	należy zastosować odpowiednią nogę podpierającą
	1800	1200	740	BNG18	780,-	52.9	0.149	3	należy zastosować odpowiednią nogę podpierającą

DODATKOWA DOPLATA DO CECHY

CECHA	SYMBOL											UWAGI
	BNG02	BNG03	BNG04	BNG05	BNG10	BNG11	BNG17	BNG18	kg	m3	szt	
PRZEPUSTY KABLOWE	40,-	40,-	40,-	40,-	40,-	40,-	40,-	40,-	0.1	0.0001	1	
MEDIABOX M04H	490,-	490,-	490,-	490,-	490,-	490,-	490,-	490,-	0.9	0.0070	1	
MEDIABOX M04	450,-	450,-	450,-	450,-	450,-	450,-	450,-	450,-	0.9	0.0070	1	
TOP ACCESS M05	150,-	150,-	150,-	150,-	150,-	150,-	150,-	150,-	0.0	0.0000	0	

LEGENDA:

- WAGA NETTO

- OBJĘTOŚĆ

- ILOŚĆ PACZEK

WIDOK I RZUT OBIEKTU	WYMIARY [mm]			SYMBOL	CENA NETTO PLN				UWAGI
	SZEROKOŚĆ	GŁĘBOKOŚĆ	WYSOKOŚĆ			kg	m3	szt	

BIURKA PROSTE

	1200	600	740	BOU12	505,-	29.8	0.067	4	
	1400	600	740	BOU14	525,-	32.8	0.072	4	
	1600	600	740	BOU16	540,-	35.9	0.078	4	
	1200	800	740	BOU19	525,-	37.8	0.069	3	
	1400	800	740	BOU20	545,-	38.3	0.076	3	
	1600	800	740	BOU21	560,-	38.9	0.083	3	
	1800	800	740	BOU22	630,-	42.0	0.090	3	
	2000	800	740	BOU27	670,-	48.3	0.097	3	

DODATKOWA DOPLATA DO CECHY

CECHA	SYMBOL											UWAGI
	BOU12	BOU14	BOU16	BOU19	BOU20	BOU21	BOU22	BOU27	kg	m3	szt	
PRZEPUSTY KABLOWE	40,-	40,-	40,-	40,-	40,-	40,-	40,-	40,-	0.1	0.0001	1	
MEDIABOX M04H	490,-	490,-	490,-	490,-	490,-	490,-	490,-	490,-	0.9	0.0070	1	
MEDIABOX M04	450,-	450,-	450,-	450,-	450,-	450,-	450,-	450,-	0.9	0.0070	1	
TOP ACCESS M05	150,-	150,-	150,-	150,-	150,-	150,-	150,-	150,-	0.0	0.0000	0	

LEGENDA:

- WAGA NETTO

- OBJĘTOŚĆ

- ILOŚĆ PACZEK

WIDOK I RZUT OBIEKTU	WYMIARY [mm]			SYMBOL	CENA NETTO PLN				UWAGI
	SZEROKOŚĆ	GŁĘBOKOŚĆ	WYSOKOŚĆ			kg	m3	szt	

ELEMENTY DO TWORZENIA UKŁADÓW BIUREK

	1200	800	740	BOX42	430,-	31.6	0.079	3		mocowanie wyłącznie do krawędzi 800mm, profil 40x40mm
	1400	800	740	BOX43	445,-	32.1	0.086	3		mocowanie wyłącznie do krawędzi 800mm, profil 40x40mm
	1600	800	740	BOX44	460,-	32.7	0.093	3		mocowanie wyłącznie do krawędzi 800mm, profil 40x40mm
	1800	800	740	BOX45	490,-	35.8	0.100	3		mocowanie wyłącznie do krawędzi 800mm, profil 40x40mm

BIURKA KSZTAŁTOWE

	1600	1200	740	BOU23	695,-	44.1	0.109	3		
	1600	1200	740	BOU24	695,-	46.1	0.109	3		
	1800	1200	740	BOU25	840,-	42.0	0.119	3		
	1800	1200	740	BOU26	840,-	44.0	0.119	3		
	1600	2410	740	BOU15	1 375,-	83.5	0.216	5		

DODATKOWA DOPLATA DO CECHY

CECHA	SYMBOL												UWAGI
	BOX42	BOX43	BOX44	BOX45	BOU23	BOU24	BOU25	BOU26	BOU15	kg	m3	szt	
PRZEPUSTY KABLOWE	40,-	40,-	40,-	40,-	40,-	40,-	40,-	40,-	80,-	0.1	0.0001	1	
MEDIABOX M04H	490,-	490,-	490,-	490,-	490,-	490,-	490,-	490,-	980,-	0.9	0.0070	1	
MEDIABOX M04	450,-	450,-	450,-	450,-	450,-	450,-	450,-	450,-	900,-	0.9	0.0070	1	
TOP ACCESS M05	150,-	150,-	150,-	150,-	150,-	150,-	150,-	150,-	300,-	0.0	0.0000	0	

LEGENDA:

- WAGA NETTO

- OBJĘTOŚĆ

- ILOŚĆ PACZEK

WIDOK I RZUT OBIEKTU	WYMIARY [mm]			SYMBOL	CENA NETTO PLN				UWAGI
	SZEROKOŚĆ	GŁĘBOKOŚĆ	WYSOKOŚĆ			kg	m3	szt	

BIURKA Z SZAFKĄ MANAGERSKĄ

	1600 1702	1600	740	BOUL20	1 525,-	92.9	0.231	8	uniwersalne (lewe / prawe)
	1800 1902	1600	740	BOUL21	1 590,-	96.0	0.238	8	uniwersalne (lewe / prawe)
	1600 1702	3210	740	BOUL40	3 045,-	182.6	0.463	15	
	1800 1902	3210	740	BOUL41	3 180,-	188.8	0.476	15	

BIURKA TYPU BENCH

	1200	1610	740	BOU32	835,-	68.9	0.137	5	
	1400	1610	740	BOU33	865,-	69.9	0.151	5	
	1600	1610	740	BOU34	905,-	71.1	0.165	5	
	1800	1610	740	BOU35	1 040,-	77.3	0.178	5	

DODATKOWA DOPLATA DO CECHY

CECHA	SYMBOL											UWAGI
	BOUL20	BOUL21	BOUL40	BOUL41	BOU32	BOU33	BOU34	BOU35	kg	m3	szt	
PRZEPUSTY KABLOWE	40,-	40,-	80,-	80,-	80,-	80,-	80,-	80,-	0.1	0.0001	1	
MEDIABOX M04H	490,-	490,-	980,-	980,-	980,-	980,-	980,-	980,-	0.9	0.0070	1	
MEDIABOX M04	450,-	450,-	900,-	900,-	900,-	900,-	900,-	900,-	0.9	0.0070	1	
TOP ACCESS M05	150,-	150,-	300,-	300,-	300,-	300,-	300,-	300,-	0.0	0.0000	0	
II GRUPA CENOWA	75,-	75,-	150,-	150,-					0.0	0.0000	0	

LEGENDA:

- WAGA NETTO

- OBJĘTOŚĆ

- ILOŚĆ PACZEK

WIDOK I RZUT OBIEKTU	WYMIARY [mm]			SYMBOL	CENA NETTO PLN				UWAGI
	SZEROKOŚĆ	GŁĘBOKOŚĆ	WYSOKOŚĆ			kg	m3	szt	

ELEMENTY DO TWORZENIA UKŁADÓW BIUREK

	1200	1610	740	BOX62	695,-	60.1	0.159	5	
	1400	1610	740	BOX64	720,-	61.1	0.173	5	
	1600	1610	740	BOX66	760,-	62.3	0.187	5	
	1800	1610	740	BOX68	880,-	68.5	0.200	5	

PRZYSTAWKA DO BIUREK

	600	800	740	PLU01	410,-	18.4	0.038	5	
	600	1000	740	PLU02	440,-	19.6	0.043	5	
	600	1200	740	PLU03	470,-	22.1	0.048	5	

DODATKOWA DOPLATA DO CECHY

CECHA	SYMBOL											UWAGI
	BOX62	BOX64	BOX66	BOX68					kg	m3	szt	
PRZEPUSTY KABLOWE	80,-	80,-	80,-	80,-					0.1	0.0001	1	
MEDIABOX M04H	980,-	980,-	980,-	980,-					0.9	0.0070	1	
MEDIABOX M04	900,-	900,-	900,-	900,-					0.9	0.0070	1	
TOP ACCESS M05	300,-	300,-	300,-	300,-					0.0	0.0000	0	

LEGENDA:

- WAGA NETTO

- OBJĘTOŚĆ

- ILOŚĆ PACZEK

WIDOK I RZUT OBIEKTU	WYMIARY [mm]			SYMBOL	CENA NETTO PLN				UWAGI
	SZEROKOŚĆ	GLĘBOKOŚĆ	WYSOKOŚĆ			kg	m3	szt	

BIURKA PROSTE

	1200	600	740	BOY12	480,-	30.4	0.076	4	
	1400	600	740	BOY14	495,-	33.4	0.081	4	
	1600	600	740	BOY16	510,-	36.5	0.087	4	
	1200	700	740	BOY22	485,-	31.7	0.066	3	
	1400	700	740	BOY24	500,-	35.1	0.073	3	
	1600	700	740	BOY26	515,-	38.7	0.079	3	
	1200	800	740	BOY02	495,-	37.3	0.075	3	
	1400	800	740	BOY03	510,-	37.8	0.082	3	
	1600	800	740	BOY04	525,-	38.4	0.089	3	

DODATKOWA DOPLATA DO CECHY

CECHA	SYMBOL												UWAGI
	BOY12	BOY14	BOY16	BOY22	BOY24	BOY26	BOY02	BOY03	BOY04	kg	m3	szt	
PRZEPUSTY KABLOWE	40,-	40,-	40,-	40,-	40,-	40,-	40,-	40,-	40,-	0.1	0.0001	1	
MEDIABOX M04H	490,-	490,-	490,-	490,-	490,-	490,-	490,-	490,-	490,-	0.9	0.0070	1	
MEDIABOX M04	450,-	450,-	450,-	450,-	450,-	450,-	450,-	450,-	450,-	0.9	0.0070	1	
TOP ACCESS M05	150,-	150,-	150,-	150,-	150,-	150,-	150,-	150,-	150,-	0.0	0.0000	0	

LEGENDA:

- WAGA NETTO

- OBJĘTOŚĆ

- ILOŚĆ PACZEK

WIDOK I RZUT OBIEKTU	WYMIARY [mm]			SYMBOL	CENA NETTO PLN				UWAGI
	SZEROKOŚĆ	GLĘBOKOŚĆ	WYSOKOŚĆ			kg	m3	szt	

BIURKA PROSTE

	1800	800	740	BOY05	590,-	41.5	0.096	3	
	2000	800	740	BOY06	610,-	47.8	0.103	3	

ELEMENTY DO TWORZENIA UKŁADÓW BIUREK

	1200	700	740	BOX32	425,-	26.3	0.068	3	mocowanie wyłącznie do krawędzi 700mm
	1400	700	740	BOX34	440,-	29.7	0.075	3	mocowanie wyłącznie do krawędzi 700mm
	1600	700	740	BOX36	455,-	33.3	0.081	3	mocowanie wyłącznie do krawędzi 700mm
	1200	800	740	BOX42	430,-	31.6	0.079	3	mocowanie wyłącznie do krawędzi 800mm
	1400	800	740	BOX43	445,-	32.1	0.086	3	mocowanie wyłącznie do krawędzi 800mm
	1600	800	740	BOX44	460,-	32.7	0.093	3	mocowanie wyłącznie do krawędzi 800mm
	1800	800	740	BOX45	490,-	35.8	0.100	3	mocowanie wyłącznie do krawędzi 800mm

DODATKOWA DOPLATA DO CECHY



CECHA	SYMBOL													UWAGI
	BOY05	BOY06	BOX32	BOX34	BOX36	BOX42	BOX43	BOX44	BOX45		kg	m3	szt	
PRZEPUSTY KABLOWE	40,-	40,-	40,-	40,-	40,-	40,-	40,-	40,-	40,-	40,-	0.1	0.0001	1	
MEDIABOX M04H	490,-	490,-	490,-	490,-	490,-	490,-	490,-	490,-	490,-	490,-	0.9	0.0070	1	
MEDIABOX M04	450,-	450,-	450,-	450,-	450,-	450,-	450,-	450,-	450,-	450,-	0.9	0.0070	1	
TOP ACCESS M05	150,-	150,-	150,-	150,-	150,-	150,-	150,-	150,-	150,-	150,-	0.0	0.0000	0	

LEGENDA:

- WAGA NETTO

- OBJĘTOŚĆ

- ILOŚĆ PACZEK

WIDOK I RZUT OBIEKTU	WYMIARY [mm]			SYMBOL	CENA NETTO PLN				UWAGI
	SZEROKOŚĆ	GLĘBOKOŚĆ	WYSOKOŚĆ			kg	m3	szt	

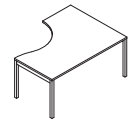
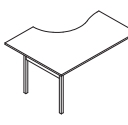
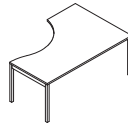
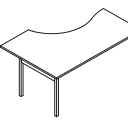
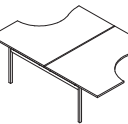

BIURKA KSZTAŁTOWE

	1600	1200	740	BOY10	645,-	43.6	0.115	3	
	1600	1200	740	BOY11	645,-	45.6	0.115	3	
	1800	1200	740	BOY17	760,-	41.5	0.124	3	
	1800	1200	740	BOY18	760,-	43.5	0.124	3	
	1600	2410	740	BOY15	1 140,-	82.9	0.228	5	

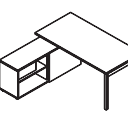
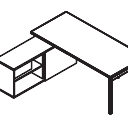
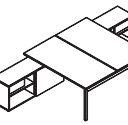
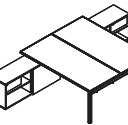

BIURKA Z SZAFKĄ MANAGERSKĄ

	1600 1702	1600	740	BOYL20	1 425,-	92.5	0.237	8	uniwersalne (lewe / prawe)
	1800 1902	1600	740	BOYL21	1 490,-	95.6	0.244	8	uniwersalne (lewe / prawe)
	1600 1702	3210	740	BOYL40	2 735,-	181.9	0.475	15	
	1800 1902	3210	740	BOYL41	2 870,-	188.1	0.488	15	

DODATKOWA DOPLATA DO CECHY

CECHA	SYMBOL												UWAGI
	BOY10	BOY11	BOY17	BOY18	BOY15	BOYL20	BOYL21	BOYL40	BOYL41	kg	m3	szt	
PRZEPUSTY KABLOWE	40,-	40,-	40,-	40,-	80,-	40,-	40,-	80,-	80,-	0.1	0.0001	1	
MEDIABOX M04H	490,-	490,-	490,-	490,-	980,-	490,-	490,-	980,-	980,-	0.9	0.0070	1	
MEDIABOX M04	450,-	450,-	450,-	450,-	900,-	450,-	450,-	900,-	900,-	0.9	0.0070	1	
TOP ACCESS M05	150,-	150,-	150,-	150,-	300,-	150,-	150,-	300,-	300,-	0.0	0.0000	0	
II GRUPA CENOWA						75,-	75,-	150,-	150,-	0.0	0.0000	0	

LEGENDA:

 - WAGA NETTO - OBJĘTOŚĆ - ILOŚĆ PACZEK

WIDOK I RZUT OBIEKTU	WYMIARY [mm]			SYMBOL	CENA NETTO PLN				UWAGI
	SZEROKOŚĆ	GLĘBOKOŚĆ	WYSOKOŚĆ			kg	m3	szt	

BIURKA Z MANUALNĄ REGULACJĄ WYSOKOŚCI

	1200	800	640 860	BOY02R	760,-	39.6	0.075	3	regulacja wysokości w zakresie 640 - 860mm, skokowo co 20mm
	1400	800	640 860	BOY03R	780,-	40.1	0.082	3	regulacja wysokości w zakresie 640 - 860mm, skokowo co 20mm
	1600	800	640 860	BOY04R	810,-	40.7	0.089	3	regulacja wysokości w zakresie 640 - 860mm, skokowo co 20mm
	1800	800	640 860	BOY05R	850,-	43.8	0.096	3	regulacja wysokości w zakresie 640 - 860mm, skokowo co 20mm
	2000	800	640	BOY06R	880,-	50.1	0.103	3	regulacja wysokości w zakresie 640 - 860mm, skokowo co 20mm

DODATKOWA DOPLATA DO CECHY



CECHA	SYMBOL									UWAGI
	BOY02R	BOY03R	BOY04R	BOY05R	BOY06R		kg	m3	szt	
PRZEPUSTY KABLOWE	40,-	40,-	40,-	40,-	40,-		0.1	0.0001	1	
MEDIABOX M04H	490,-	490,-	490,-	490,-	490,-		0.9	0.0070	1	
MEDIABOX M04	450,-	450,-	450,-	450,-	450,-		0.9	0.0070	1	
TOP ACCESS M05	150,-	150,-	150,-	150,-	150,-		0.0	0.0000	0	

LEGENDA:



- WAGA NETTO

- OBJĘTOŚĆ

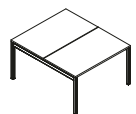
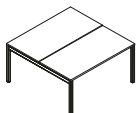

- ILOŚĆ PACZEK

WIDOK I RZUT OBIEKTU	WYMIARY [mm]			SYMBOL	CENA NETTO PLN				UWAGI
	SZEROKOŚĆ	GŁĘBOKOŚĆ	WYSOKOŚĆ			kg	m3	szt	

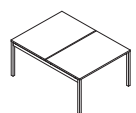
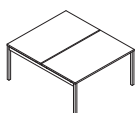
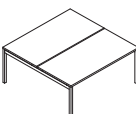
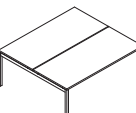

BIURKA TYPU BENCH



	1200	1410	740	BOY42	770,-	57.2	0.131	5	
	1400	1410	740	BOY44	800,-	64.0	0.143	5	
	1600	1410	740	BOY46	850,-	71.2	0.156	5	
	1200	1610	740	BOY32	795,-	68.3	0.149	5	
	1400	1610	740	BOY33	820,-	69.3	0.163	5	
	1600	1610	740	BOY34	865,-	70.5	0.176	5	
	1800	1610	740	BOY35	995,-	76.7	0.190	5	

DODATKOWA DOPLATA DO CECHY





CECHA	SYMBOL											UWAGI
	BOY42	BOY44	BOY46	BOY32	BOY33	BOY34	BOY35		kg	m3	szt	
PRZEPUSTY KABLOWE	80,-	80,-	80,-	80,-	80,-	80,-	80,-		0.1	0.0001	1	
MEDIABOX M04H	980,-	980,-	980,-	980,-	980,-	980,-	980,-		0.9	0.0070	1	
MEDIABOX M04	900,-	900,-	900,-	900,-	900,-	900,-	900,-		0.9	0.0070	1	
TOP ACCESS M05	300,-	300,-	300,-	300,-	300,-	300,-	300,-		0.0	0.0000	0	

LEGENDA:

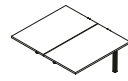
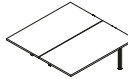
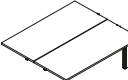

 - WAGA NETTO - OBJĘTOŚĆ - ILOŚĆ PACZEK

WIDOK I RZUT OBIEKTU	WYMIARY [mm]			SYMBOL	CENA NETTO PLN				UWAGI
	SZEROKOŚĆ	GŁĘBOKOŚĆ	WYSOKOŚĆ			kg	m3	szt	

ELEMENTY DO TWORZENIA UKŁADÓW BIUREK



	1200	1410	740	BOX52	670,-	49.4	0.137	5	
	1400	1410	740	BOX54	700,-	56.2	0.150	5	
	1600	1410	740	BOX56	745,-	63.4	0.162	5	
	1200	1610	740	BOX62	695,-	60.1	0.159	5	
	1400	1610	740	BOX64	720,-	61.1	0.173	5	
	1600	1610	740	BOX66	760,-	62.3	0.187	5	
	1800	1610	740	BOX68	880,-	68.5	0.200	5	

DODATKOWA DOPLATA DO CECHY



CECHA	SYMBOL											UWAGI
	BOX52	BOX54	BOX56	BOX62	BOX64	BOX66	BOX68		kg	m3	szt	
PRZEPUSTY KABLOWE	80,-	80,-	80,-	80,-	80,-	80,-	80,-		0.1	0.0001	1	
MEDIABOX M04H	980,-	980,-	980,-	980,-	980,-	980,-	980,-		0.9	0.0070	1	
MEDIABOX M04	900,-	900,-	900,-	900,-	900,-	900,-	900,-		0.9	0.0070	1	
TOP ACCESS M05	300,-	300,-	300,-	300,-	300,-	300,-	300,-		0.0	0.0000	0	

LEGENDA:

 - WAGA NETTO - OBJĘTOŚĆ - ILOŚĆ PACZEK

WIDOK I RZUT OBIEKTU	WYMIARY [mm]			SYMBOL	CENA NETTO PLN				UWAGI
	SZEROKOŚĆ	GŁĘBOKOŚĆ	WYSOKOŚĆ			kg	m3	szt	

PRZYSTAWKA DO BIUREK

	600	800	740	PLY01	360,-	18.7	0.042	5	
	600	1000	740	PLY02	390,-	19.9	0.047	5	
	600	1200	740	PLY03	420,-	22.4	0.052	5	

LEGENDA:

 - WAGA NETTO - OBJĘTOŚĆ - ILOŚĆ PACZEK

WIDOK I RZUT OBIEKTU	WYMIARY [mm]			SYMBOL	CENA NETTO PLN				UWAGI
	SZEROKOŚĆ	GŁĘBOKOŚĆ	WYSOKOŚĆ			kg	m3	szt	

BIURKA PROSTE

	1200	800	740	BVG02	415,-	45.3	0.096	3	
	1400	800	740	BVG03	445,-	49.6	0.104	3	
	1600	800	740	BVG04	485,-	53.5	0.113	3	
	1800	800	740	BVG05	535,-	57.9	0.120	3	

BIURKA KSZTAŁTOWE

	1600	1200	740	BVG10	670,-	57.5	0.135	3	
	1600	1200	740	BVG11	670,-	57.5	0.135	3	
	1800	1200	740	BVG17	720,-	65.5	0.145	3	
	1800	1200	740	BVG18	720,-	65.5	0.145	3	

DODATKOWA DOPLATA DO CECHY

CECHA	SYMBOL											UWAGI
	BVG02	BVG03	BVG04	BVG05	BVG10	BVG11	BVG17	BVG18	kg	m3	szt	
PRZEPUSTY KABLOWE	40,-	40,-	40,-	40,-	40,-	40,-	40,-	40,-	0.1	0.0001	1	
MEDIABOX M04H	490,-	490,-	490,-	490,-	490,-	490,-	490,-	490,-	0.9	0.0070	1	
MEDIABOX M04	450,-	450,-	450,-	450,-	450,-	450,-	450,-	450,-	0.9	0.0070	1	
TOP ACCESS M05	150,-	150,-	150,-	150,-	150,-	150,-	150,-	150,-	0.0	0.0000	0	

LEGENDA:

- WAGA NETTO

- OBJĘTOŚĆ

- ILOŚĆ PACZEK

WIDOK I RZUT OBIEKTU	WYMIARY [mm]			SYMBOL	CENA NETTO PLN					UWAGI
	SZEROKOŚĆ	GLĘBOKOŚĆ	WYSOKOŚĆ			kg	m3	szt		
	1050	107	120	SG12	95,-	2.0	0.018	1		do biurek pojedynczych o szerokości 1200 i 1400mm
	1450	107	120	SG16	110,-	3.0	0.025	1		do biurek pojedynczych o szerokości 1600 i 1800mm
	1050	396	130	SG220	100,-	2.0	0.081	1		do benchy o szerokości 1200 i 1400mm oraz benchy OGI A
	1450	396	130	SG260	120,-	2.0	0.111	1		do benchy o szerokości 1600 i 1800mm oprócz benchy OGI A
	80	80	23	PK80	30,-	0.1	0.000	1		przelot kablowy 02 - szary, 08 - czarny, 67 - biały
	275	120	140	M04	450,-	0.0	0.001	0		4x230V, 2xRJ45, 1xUSB
	275	120	140	M04H	490,-	0.0	0.001	0		4x230V, 2xRJ45, 1xUSB, 1xHDMI
	275	120	25	M05	150,-	0.3	0.002	1		TOP ACCESS
	460	89	120	E64	70,-	0.5	0.001	1		kanał kablowy M009 - aluminium półmat
	580	162	123	S69	80,-	1.0	0.015	1		09 - aluminium
	140	140	750	S94	220,-	1.0	0.004	1		przewodzenie kabli (sprężyna) kolor: 09 - aluminium

LEGENDA:

- WAGA NETTO

- OBJĘTOŚĆ

- ILOŚĆ PACZEK

WIDOK I RZUT OBIEKTU	WYMIARY [mm]			SYMBOL	CENA NETTO PLN				UWAGI
	SZEROKOŚĆ	GLĘBOKOŚĆ	WYSOKOŚĆ			kg	m3	szt	
	470	42	34	S95	65,-	1.0	0.001	1	pionowy organizer kablowy, pasuje do biurek OGI Y oraz do nogi środkowej OGI A o profilu 40mm
	470	62	34	S93	65,-	1.0	0.002	1	pionowy organizer kablowy, pasuje do biurek DRIVE, YAN, OGI A, OGI Q i OGI U o profilu 60mm
	140	70	750	S81	130,-	1.1	0.008	1	prowadzenie kabli (kręgosłup) kolor: 09 - aluminium
	1000	70	35	S82	70,-	1.0	0.005	1	grzebień do mocowania kabli pod blatem, 09 - aluminium
				AK3	32,-	0.2	0.000	1	rzepy do mocowania kabli, 02 - szary (3 z wkrętami, 3 bez wkrętów)
				AK5	40,-	0.2	0.000	1	zaczep do prowadzenia kabla 5szt., 08 - czarny
	212	460	617	S83	140,-	2.6	0.027	1	zawiesz do komputera, kolor: M009 - aluminium półmat, M015 - biały półmat, M154 - antracyt półmat
	220	470	148	S73	150,-	3.2	0.002	1	wózek do komputera, 26 - aluminium satinato
	610	400	85	C01	130,-	0.5	0.010	1	półka pod klawiaturę do biurek na gł. 800mm, 02 - szary
	45	50	57	S11	30,-	0.0	0.001	0	wieszak na torebkę

LEGENDA:

- WAGA NETTO

- OBJĘTOŚĆ

- ILOŚĆ PACZEK